

Sol-Tec V3

Salt Nebulizing System



ⓔN Installation and operation manual

Made in Germany

CE IP44



Table of contents

1	Information regarding these instructions / general information.....	3
1.1	Scope of validity.....	4
1.2	Target group.....	4
1.3	Symbols used.....	4
1.4	Warranty.....	5
1.5	Further information.....	6
2	Safety.....	7
2.1	Appropriate use.....	7
2.2	Safety instructions:.....	7
3	Product description - delivery scope.....	8
3.1	Delivery scope / accessories.....	8
3.2	Product description.....	10
3.3	Identification of the device / name plate.....	10
3.4	Technical data.....	11
3.5	Transport / storage.....	11
4	Assembly.....	12
4.1	Selecting the place of installation.....	12
4.2	Assembly information (installation suggestion).....	12
4.3	Mechanical installation.....	14
4.4	Hydraulic installation.....	15
4.5	Electrical installation.....	16
5	Initial operation.....	18
5.1	Commissioning - comments.....	18
5.2	Commissioning - procedure.....	18
6	Operation / handling.....	28
6.1	General.....	28
6.2	Controller - software.....	28
6.3	The main menu.....	31
6.4	Operating modes menu.....	33
6.5	Settings menu.....	43
6.6	Service menu.....	51
6.7	Login.....	55
6.8	Logout.....	55
6.9	Optional functions.....	55
6.10	Top up consumables.....	55

7	Maintenance, service, faults.....	56
7.1	Device maintenance.....	56
7.2	Regular water inspection.....	56
7.3	Fault removal / fault codes	56
8	Shutting down – Storage – Disposal	60
8.1	General.....	60
9	Documents.....	61
9.1	Terminal plans.....	61
9.2	Commissioning protocol / instruction	63
9.3	Operating data sheet	64
9.4	Maintenance protocol	66
9.5	Spare parts list, wearing parts list, consumables list.....	68
10	Appendices.....	70

Service Address

EOS Saunatechnik GmbH
 Schneiderstriesch 1
 35759 Driedorf
 Germany
 Tel: +49 (0)2775 82-514
 Fax: +49 (0)2775 82-431
 servicecenter@eos-sauna.de
 www.eos-sauna.de

Please keep this address in a safe place together with the installation guide.
 To help us answer your questions quickly and competently please provide the information printed on the type shield including the model, item no. and serial no., in all inquiries.

1 Information regarding these instructions / general information

1.1 Scope of validity

These instructions describe the function, installation, commissioning and operation of the V3 brine nebulization system station and its appropriate accessories.

The operating instructions must be carefully read before using and maintaining the device and must be stored next to the device for direct use!

1.2 Target group

Only our authorised partners and persons who were instructed regarding the functions of the device and have read and understood the operating instructions may work on the system.

Electrotechnical connection work may only be performed by appropriately trained specialist staff!

1.3 Symbols used

The following types of safety instructions and general instructions are used in this document:



DANGER!

"DANGER" identifies a safety instruction that is neglected at the risk of severe or life-threatening injuries or major damage to goods! Including anger due to electrical voltage!



CAUTION!

"CAUTION" identifies safety instructions that are neglected at the risk of injuries, damage to health or damage to goods!



ATTENTION!

"ATTENTION" identifies safety instructions that are neglected at the risk of damage to goods!



CAUSTIC !

"Caustic" identifies safety instructions that are neglected at the risk of injuries or damage to goods.



ESD-SENSITIVE !

"ESD SENSITIVE" identifies electronic components that can be damaged by electrostatic discharge. The generally known precautions regarding ESD-sensitive devices must be adhered to when handling these devices!



HINT !

A "Hint" characterises information that may help to improve the operation.

1.4 Warranty

The manufacturer shall assume liability in accordance with the currently applicable statutory regulations. The packaging for all of our products is designed for the shipping of individually packed goods (pallet). We expressly point out that our packaging is not suitable for individual shipments via parcel post. The manufacturer shall accept no liability for damage incurred as a result of improper packaging in an individual shipment.

General warranty conditions

The manufacturer's warranty shall apply only in the event that installation, operation and maintenance have been carried out in accordance with the manufacturer's specifications contained in the assembly instructions and instructions for use.

- The warranty period shall commence from the date on which proof of purchase is provided and shall be limited, in principle, to 24 months.
- Warranty services shall be performed only if the proof of purchase relating to the equipment can be presented.
- Any and all warranty claims shall become void if modifications are made to the equipment **without the manufacturer's express consent.**
- Any warranty claim shall likewise become void in the case of defects that arise due to repairs or interventions made by unauthorized persons or due to improper use.
- In the case of warranty claims, the serial and article numbers must be indicated together with the designation and a meaningful description of the fault.
- This warranty shall cover defective equipment parts, with the exception of normal wear parts. Wear parts shall include, among other things, light sources, starters, gas or oil pressure dampers as well as acrylic glass panes, tubular heating elements and sauna heater stones.
- Only original replacement parts may be used within the warranty.

- Service visits by outside companies shall require a written order to be issued by our service department.
- The equipment in question shall be sent to our service department by the Ordering Party and at its expense.
- Electrical assembly and installation work, including in the event of service or replacement, **shall be carried out at the Customer's expense and shall not be borne by the manufacturer.**

Complaints in respect of our products shall be reported to the specialist trader responsible and shall be exclusively handled via the latter.

The manufacturers General Terms and Conditions of Business, as amended, shall apply in addition to the foregoing terms and conditions of service.



HINT!

Please send a completed commissioning protocol together with the defective part to EOS to maintain your warranty claims. We reserve the right to settle the warranty claim when no completed commissioning protocol is available.



Attention!

Modification of the device is not permitted. Warranty and product liability claims become void when this requirement is not fulfilled.

1.5 Further information

Further information regarding specific topics such as e.g. dosing performance or description of the operating parameters is available from your specialist dealer.

2 Safety

2.1 Appropriate use

The Sol-Tec V3 brine nebulization station may only be used for the purposes specified in *Section 3.2* of the product description! The locally applicable regulations (such as accident prevention regulations, German mandatory accident insurance and worker safety regulations) must be adhered to!

2.2 Safety instructions:

The operating instructions must be carefully read and considered before installation and use!

Work on the system and changes to the settings may only be performed by trained and instructed persons! It is particularly important that the regulations for worker safety and accident prevention as well as for wearing protective clothing are adhered to.

2.2.1 Handling of chemicals, risks to persons and the environment



Important information regarding chemicals is provided in the safety data sheets of the chemical manufacturers!

It is essential to wear protective clothing when handling chemicals!

In emergencies relating to the handling of chemicals, you can contact a Poison Emergency Call Centre! Example for Germany:

Emergency call number:

Poison Emergency Call Munich (or any other poison centre)

Telephone: +49 89 19240

2.2.2 Protective measures and behavioural rules



Caution!

Modification of the device is not permitted!

3 Product description - delivery scope

3.1 Delivery scope / accessories

The Sol-Tec V3 brine nebulization station is used to generate a salty sea climate in steam rooms. It consists of the following components, which are installed on a mounting plate and ready to use:

- Microprocessor controller SSD + BET in housing
- 1 or 2 membrane dosing pumps
- Mounting plate with bracket for a brine polyethylene container.
- Pressure monitoring
- Nebuliser nozzle made of stainless steel with plastic cover, wall feed-through and 5 m dosing line made of PTFE
- Disinfection set with disinfection tablet, mixing container and nozzle adapter
- Germ-free brine solution in the polyethylene container

The following options are available as accessories:

- Button plate with flush-mounted box
- Second nebuliser nozzle for rooms larger than 25m² floor area
- Second membrane pump
- Nozzle cover made of stainless steel

Sol-Tec V3 overview

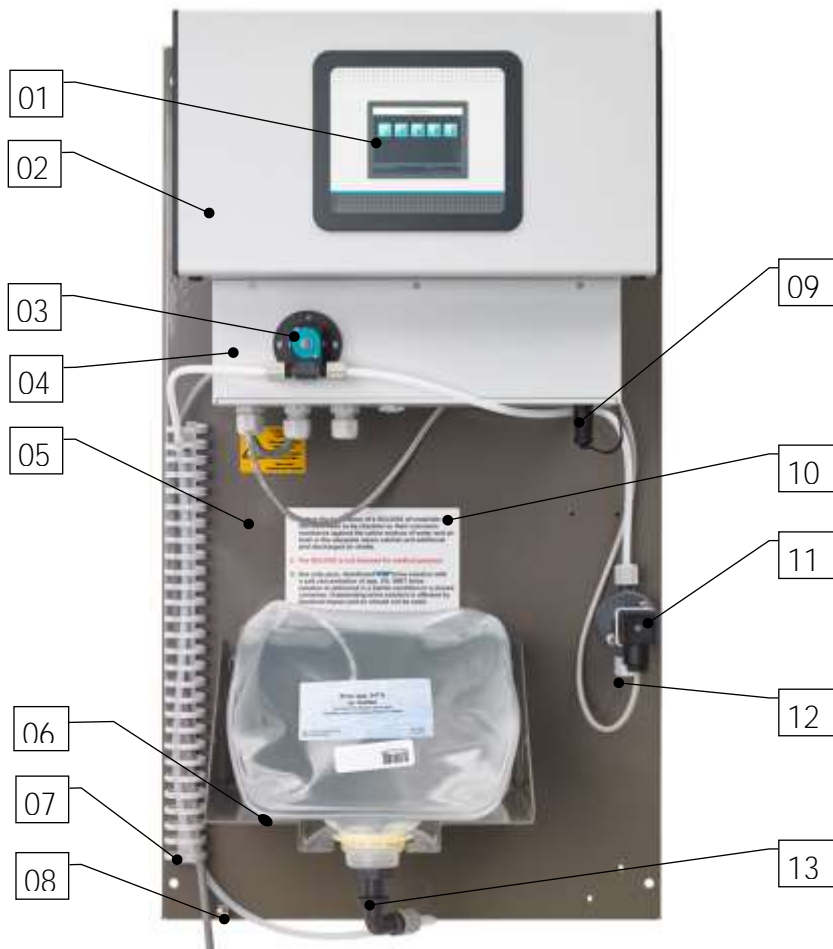

Figure 1, Soldos V3 brine nebulization station

- 01 Touch display
- 02 Controller housing
- 03 Membrane pump
- 04 Pump lid
- 05 Mounting plate
- 06 Brine polyethylene container on bracket
- 07 Cable routing
- 08 Grounding connection
- 09 Wall socket for button connection
- 10 Safety instructions:
- 11 Pressure switch
- 12 Hose connection to nozzle
- 13 Pluggable canister connection
- 14 Main fuse
- 15 Main switch

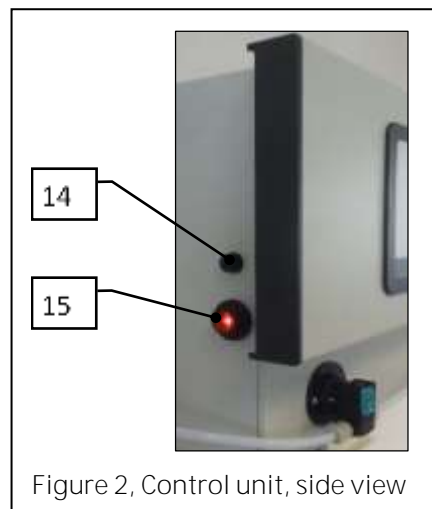

Figure 2, Control unit, side view

3.2 Product description

The Sol-Tec V3 brine nebulization station is used to generate a salty sea climate in steam rooms. The brine is provided in a sterile polyethylene container that is filled in a germ-free manner. The germ-free brine solution is pumped by a membrane pump under high pressure through a fine nozzle. The brine solution is thereby nebulised and distributed in the room. A salty sea climate forms after a short period. The dosing capacity is sufficient for rooms up to approx. 25m² floor area.

The device is operated by using a 3.2" touch display with operating unit and three freely selected operating modes. Cycle operation, button operation and external control including a weekly programme. A special disinfection programme is available for disinfection.



ATTENTION!

The Sol-Tec V3 is not suitable for saunas!

The Sol-Tec V3 does not have medical approval!

3.3 Identification of the device / name plate

Enter the data on the name plate of your device here!

Array 1: Enter serial No.

Array 2: Enter manufacturing date

Typ: Sol-Tec V3
Art.: 94.6246 Serien Nr.: <input type="text"/>
230V - 1~ 50Hz - P: 50 W
Herstellung <input type="text"/>
CE EOS Saunatechnik GmbH
Schneiderstriesch 1
D-35759 Driedorf

Figure 3, Name plate, Sol-Tec V3

3.4 Technical data

	Sol-Tec V3	
Item no.		
Dimensions and weights:		
External dimensions	47 x 71 x 24cm (width x height x depth)	
Space requirements incl. operation and maintenance	100 x 200 x 100cm (width x height x depth)	
Empty weight / operating weight	Approx. 15kg / 16kg	
Connection data		
Electrical connection data	230V AC, 50Hz, 0.05kW, two-pin earthed plug	
Hydraulic connection data	---	
Drain connection required	---	
Protection class	IP44	
Nominal pressure / operating pressure	PN16 / max. 11barg	
Operating data:		
Brine volume in polyethylene container	5l	
Brine nebulising capacity	100ml/min	
Medium temperature	5°C to 35°C	
Ambient temperature	5°C to 35°C	
Humidity in utility room	Max. 70%	
Degree of saturation of the brine mist	Max. 5% at the nozzle outlet	
Ventilation and extraction	Recommended for the utility room	
Software version	---	
Hardware version	V1.1	

3.5 Transport / storage

The device must be checked for possible transport damage immediately after receipt.



Attention!

The device can get damaged by frost or high temperatures. Prevent exposure to frost during transport and storage! Do not store the device next to objects with high heat radiation or directly exposed to sunlight. The device may only be transported and stored in its original packaging. Careful handling must be ensured.

4 Assembly

4.1 Selecting the place of installation

The place of installation must have the following characteristics:

1. The system must be protected against direct sunlight.
2. An electrical power connection with ground contact must be available.
3. Good air supply and extraction are recommended for the installation room.

4.2 Assembly information (installation suggestion)

The Sol-Tec V3 is mounted on a wall in the utility room. Consider the space required for operation and maintenance of the device.



ATTENTION:

The Sol-Tec V3 is not intended for installation in the open!

The following work must be performed before starting the installation:

- Warning and information signs according to the locally applicable accident prevention regulations (Germany: GUV-V D05) must be attached at the positions prescribed.
- All materials must be tested in a steam bath and the ventilation pipes for corrosion resistance against a 5% brine solution before installing a SOLDOS unit!
- Only highly purified, disinfected EOS brine with max. 5% salt content should be used!

Installation plan

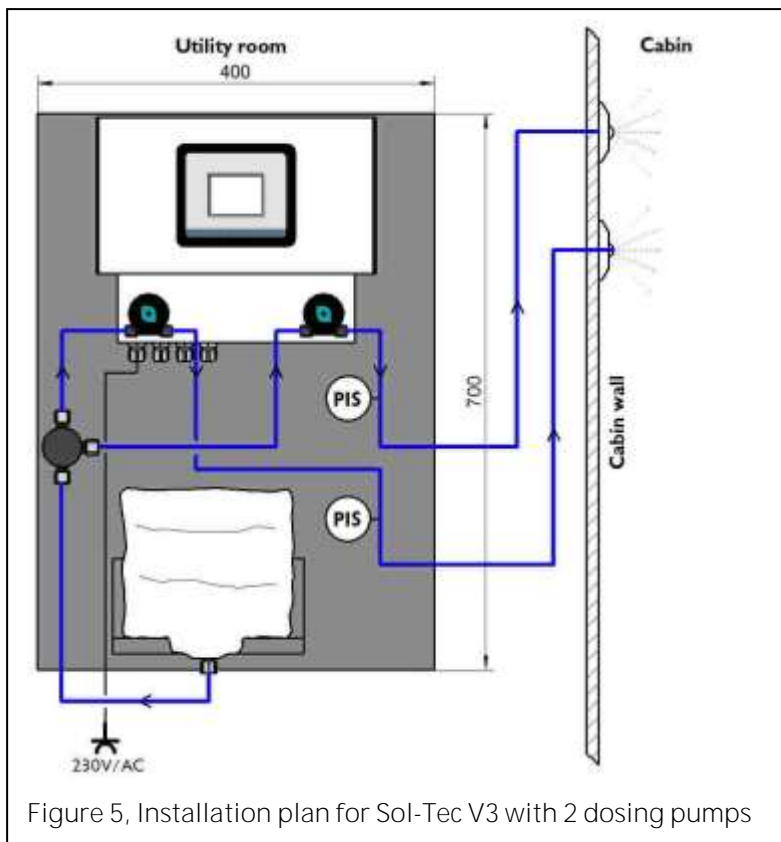
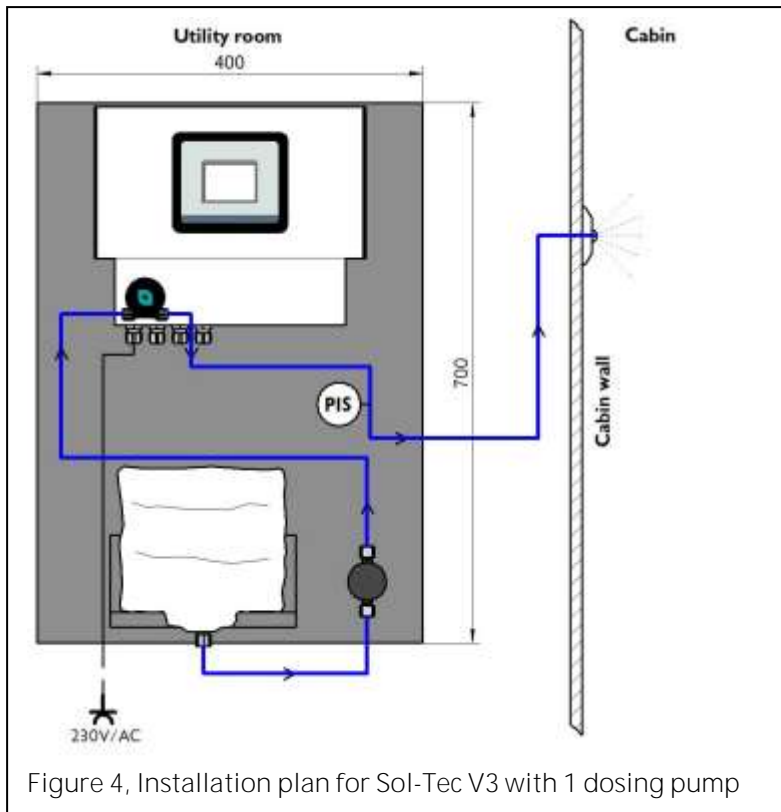

4.3 Mechanical installation

Installing the brine nebulising nozzle

The nozzle must be mounted on a higher level than the nebulization station with the brine container in order to prevent the brine container from running empty!

A non-return valve must be installed in the dosing line when this is not possible.

A hole of approx. 40mm must be drilled through the cabin wall (see Figure) for the installation of the nozzle part and the wall feed-through. The hole should have a distance of 20-30cm to the cabin ceiling. The hole should be as far as possible from the exhaust port. The best place is directly over the steam inlet opening. The wall feed-through is included in the delivery scope and is glued into the hole in a diffusion tight manner.



Nozzle part



Wall feed-through

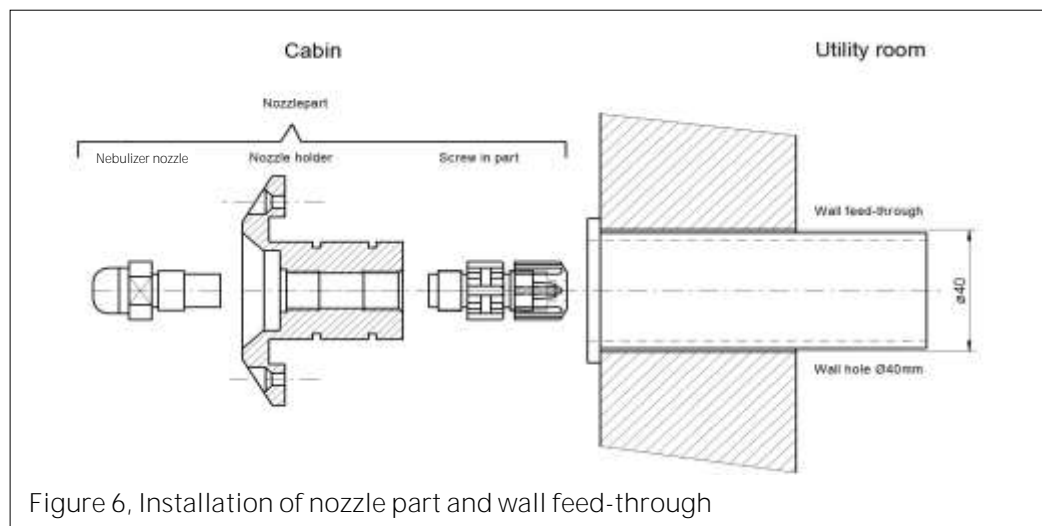

The nozzle part consist of a nozzle cover with nebuliser nozzle and hose connection and is delivered as an assembled unit.

The dosing line is made of PTFE 4x1mm, is ducted from the outside of the room through the wall feed-through and connected to the hose connector of

the nozzle part. The O-rings of the nozzle part are lightly greased with the grease supplied and the nozzle part is slid into the wall feed-through and fastened to the wall with the 2 screws provided.

We recommend to install the dosing lines within special protective material (insulation). (Pressure shocks of the membrane pump.) Ensure that the dosing line is freely moveable towards the rear so that the nozzle can be removed when required (at least 10 cm).

Installing the button (optional)

A flush-mounted cover is recommended for installing the button. The button and the flush-mounted cover can be ordered as optional accessories. During the installation the cover is fixed against the wall and sealed against the lining of the room. An empty conduit with 25 mm inside diameter should be selected when an empty conduit for the button cable is to be installed. Care must be taken during the installation that the conduit does not fall short of a 30 cm minimum bending radius. The plug-in-ready button cable must only be pulled in and connected.

The dimensions for buttons and UP covers are provided below:

The button plate is connected to the flush-mounted cover / wall with 4 screws. See figure

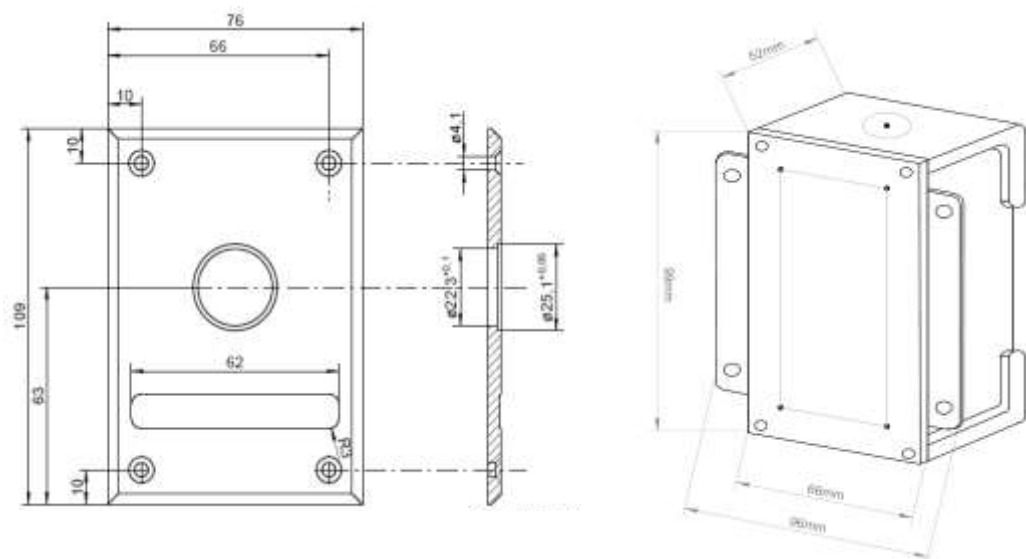

ATTENTION!

The button plate must be sealed against the room wall with suitable sealing material to prevent humidity from penetrating behind the button plate!

4.4 Hydraulic installation

Install the dosing line by starting at the nozzle part of the brine nebulization station and then connecting it to the hose connection (12).



ATTENTION !

Do not kink the dosing line when routing it to the room! It is essential to re-install a new dosing line when this happens during the installation.

The length of the dosing line affects the pump operation time in the disinfection program. It is therefore necessary to note the length of hose installed in the disinfection protocol in *Section 9.4.1*.

4.5 Electrical installation



DANGER DUE TO HIGH VOLTAGE !

The system must be switched to a voltage-free state before any electrical work is performed!



ATTENTION !

The electronic components in the Sol-Tec V3 controller are sensitive to electrostatic discharge. The generally known precautions regarding ESD-sensitive devices must be adhered to when handling these electronic components.

This implies in particular:

- Do not pull plug-in connections while they are live.
- Discharge yourself for at least 5 seconds before you directly touch these devices, e.g. by touching a grounded part of the system or by wearing an ESD discharge band that is connected to ground.

Assembly:

- The Sol-Tec V3 is connected to the power mains via a safety power socket (230V, 50Hz).
- Electrical wiring: See circuit diagram and terminal plan in *Section 9.1, Terminal plans*.

Connection of the floating collective fault message to the building management system according to the terminal plan supplied.

Additional work for a connection to an external control centre (building management system)

Connection of an external control signal for "Light and sound effects" according to the terminal plan supplied.

5 Initial operation

5.1 Commissioning - comments

The work described here may only be performed by appropriately trained, specialist staff of a specialist company or by persons familiar with the operating instructions. The systems installed must be inspected for appropriate installation and tightness before commissioning.

Use the commissioning protocol in *Section 9.2 for the commissioning procedure*.

The device is provided with factory settings when it is delivered. Adjust the standard parameters to the desired operating mode during commissioning and enter these values into the operating data sheet shown in *Section 9.3*.

5.2 Commissioning - procedure

Insert the safety connector into an appropriate mains socket and switch on the device at the main switch (*Pos 15, Page 9*).



ATTENTION !

The initial operation requires that the length of the dosing line is entered at the touch panel, the pump is bled and disinfection is performed.

Log in with your password as Technician 2 at User Level 3 for that purpose. (for procedure see Section 6.3.1).

Enter the hose length:

Open the **Settings** → **Dosing** menu and enter the actually installed length of hose at the display. The maximum permitted hose length is 30m!



Save the input with the **SAVE** button.

Bleeding the pump:

The respective membrane pump must be bled to ensure that the lines are full of liquid. The device shows "Brine empty" during disinfection or operation when the pipes are not filled.

Proceed as follows to bleed the pumps:

- Connect a container filled with approx. 200ml water to the respective membrane pump.
- Open the menu **Service menu** → **Venting pump**.

Display for 1 membrane dosing pump



Display for 2 membrane dosing pumps



- Keep the respective Start button pressed for 5 seconds! The respective membrane pump starts up and fills the line from the polyethylene container. Repeat this process until the lines are full.

5.2.1 Disinfecting and rinsing the Sol-Tec V3

Disinfection must be performed during initial operation and every 28 days. Each new brine polyethylene container is supplied with a disinfection tablet.

Check the correct date on the display and set it if necessary! *See Section 6.5.1.2.*

The disinfection should preferably be performed after or before the operation of the system, when no users are inside the room.



CAUTION!

It must be ensured before starting the disinfection that no person remains in the room during disinfection. The *nozzle adapter (19)* with hose is connected to nebuliser nozzle, so that exuding liquid can be collected in a vessel or be directly ducted into the drain.

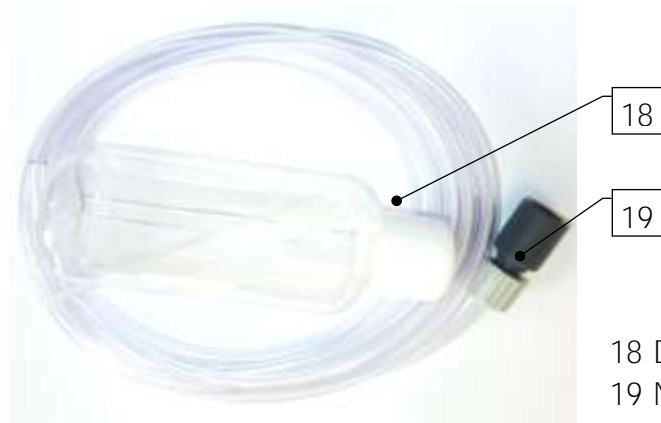

18 Disinfection set complete
19 Nozzle adapter (holder)

Figure 7, Disinfection set (18)



ATTENTION!

Enter each disinfection in *Section 9.4.1* of the disinfection protocol.

1. Call up Disinfection as follows: **Menu** → **Service menu** → **Disinfection**.



2. Press the upper **Start** button and follow the menu logic.



3. Fill the empty bottle provided with the disinfection set (18) with water. The amount of water depends on the length of the dosing line from the nozzle to the room wall.
 - Add 200 ml of water per started 10-m hose section to the bottle and add one SOLDOS disinfection tablet, Item No. 19871, per 200 ml of water. For example, when the pipe is 11m long, fill 400ml of water into the bottle and add 2 disinfection tablets.
 - Shake the bottle until the tablet(s) are dissolved.
 - Thereafter, press the **OK** button.



HINT!

The polyethylene container is already connected when the device is delivered to protect it from pollution.

4. Unscrew the polyethylene container lid and pour the disinfection solution from the bottle into the polyethylene container. Thereafter, press the **OK** button.



5. Reconnect the polyethylene container filled with disinfection solution and place it onto the bracket. Proceed as described in the following section to do this.

5.2.1.1 Place the brine container onto the SOLDOS

1. Remove the polyethylene container from the bracket and unscrew the original cap from the polyethylene container.

2. Pull off the SOLDOS polyethylene container connection from the suction line nipple.



3. Screw the polyethylene container connection onto the polyethylene container.



4. Plug the suction line with nipple into the polyethylene container connection.



5. Turn the connected container on its head and push it into the bracket. Care must be taken that the yellow flange ring is located in the appropriate guide.



Connecting the polyethylene container

5.2.1.2 Activate disinfection and rinsing



1. Connect the nozzle adapter (19) of the disinfection set supplied (18) to the nozzle in the appropriate room and duct the exuding disinfecting solution into one of the plastic containers or directly into the floor drain.



CAUTION!

Ensure that no persons remain in the respective room.

2. Press the **OK** button to activate disinfection.
3. The dosing pump starts up and the disinfection solution is transported through the whole system. The disinfection time is 90 seconds per 10m of hose length.

The disinfection data are shown.

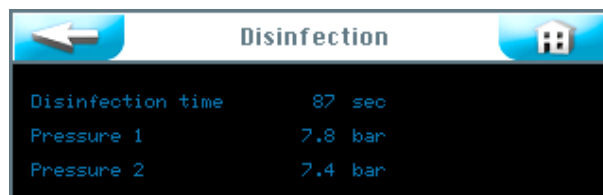

Pressure 2 optional

The exposure time (11 min) is shown.



The disinfection program is completed once the exposure time has expired. The disinfection has to be repeated when a fault message occurs.



- Empty the brine polyethylene container with the remaining disinfection solution, rinse it and retain it for the next disinfection.
- Connect a new, unused brine polyethylene container with 5% brine solution to die dosing line. See *Section 5.2.1.1, Place the brine container onto the SOLDOS.*
- Thereafter, press the button. The Rinsing programme step will automatically take place.



Follow the menu logic with .

The dosing pump starts up and the brine is transported through the whole system.

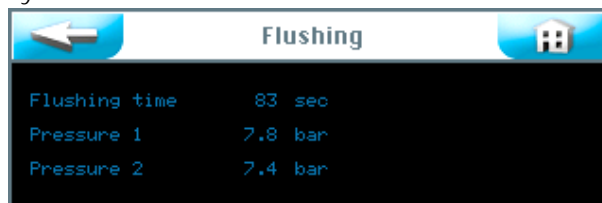

The rinsing time and rinsing pressure are shown.



The rinsing process is completed.

Rinsing must be repeated in the event of a fault message.

- Remove the nozzle adapter (19) on the nozzle of the respective room after rinsing was successful.
- It is recommended to clean the room thereafter.
- The device is now appropriately disinfected and rinsed and therefore ready for operation.

Rinsing and disinfection activities are logged by the data logger.

5.2.2 Rinsing activation

Proceed as follows when you want to perform rinsing without disinfection. Call up Rinsing by selecting **Menu** → **Service menu** → **Disinfection**.



Press the lower **Start** button to start rinsing.



Follow the menu logic with **OK**.



- Ensure that no persons remain in the room concerned!
- Connect the nozzle adapter (19) of the disinfection set supplied (18) to the nozzle in the appropriate room and duct the exuding solution into one of the plastic containers or directly into the floor drain.
- Press the **OK** button.

The dosing pump starts up and the brine is transported through the whole system.

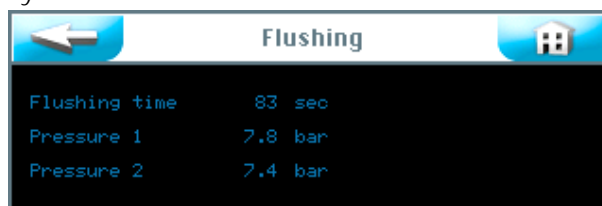

The rinsing time and rinsing pressure are shown.



The rinsing process is completed.

Rinsing must be repeated in the event of a fault message.

- Remove the nozzle adapter (19) on the nozzle in the respective room after rinsing was successful.
- It is recommended to clean the room thereafter.
- The device is then ready to use.

Rinsing and disinfection activities are logged by the data logger.

6 Operation / handling

6.1 General

The work described here may only be performed by appropriately trained and instructed persons. Alternatively, this can be done by operating personnel who have fully read and understood the operation instructions and are familiar with the device.

The operation can be started once all commissioning preparations have been completed.



CAUTION!

Disinfection as described in Section 5.2.1, *Disinfecting and rinsing the Sol-Tec V3*, must be performed and documented during initial operation and before use after more than 28 days of inactivity to protect against germs and bacteria.

It is not relevant how long the device has been used during this time.

6.2 Controller - software

The controller of the Sol-Tec V3 is operated by using a touch display on the front of the device.

External control signals (e.g. button) and the fault indication can be connected at the control panel in the housing as required.



Figure 9, Control unit

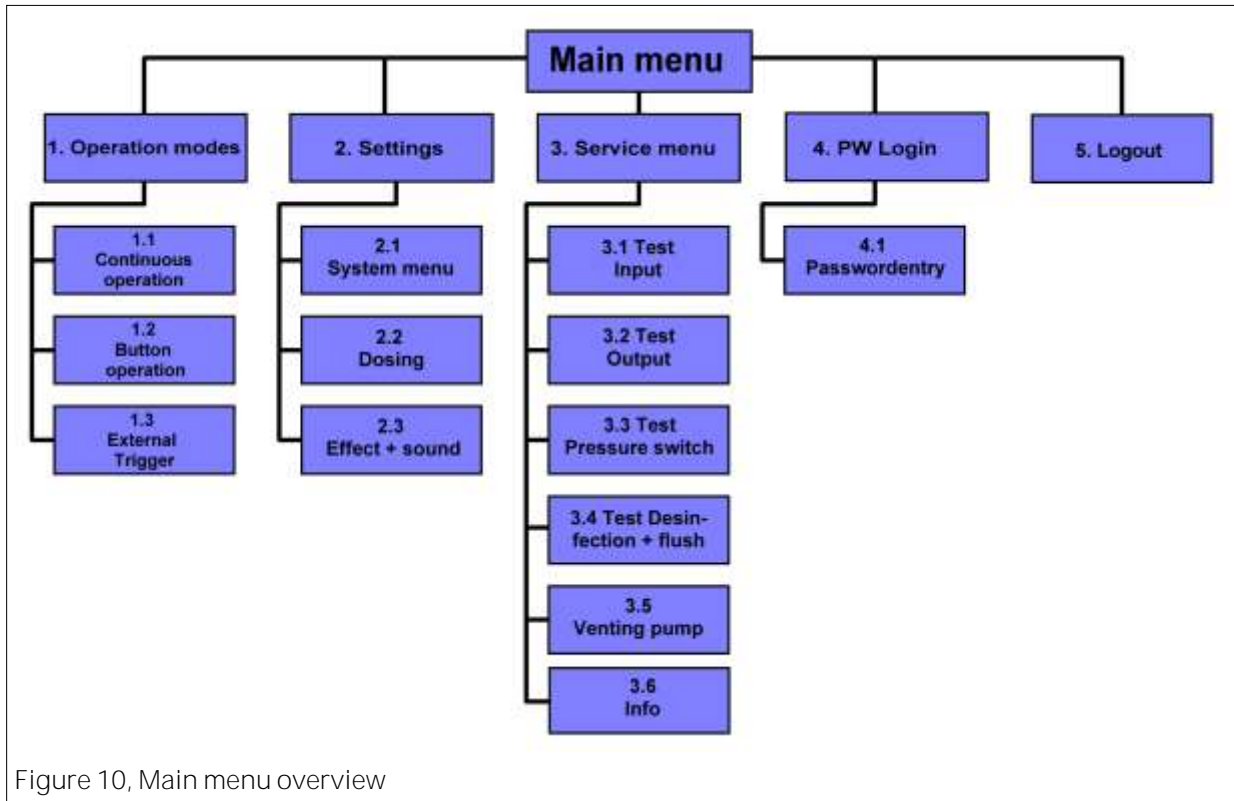

Figure 8, Touch screen stylus

A touch screen stylus is included in the delivery scope to make usage easier and protect the touch display.

Controller menu structure

Overview main menu



Operating modes sub-menu

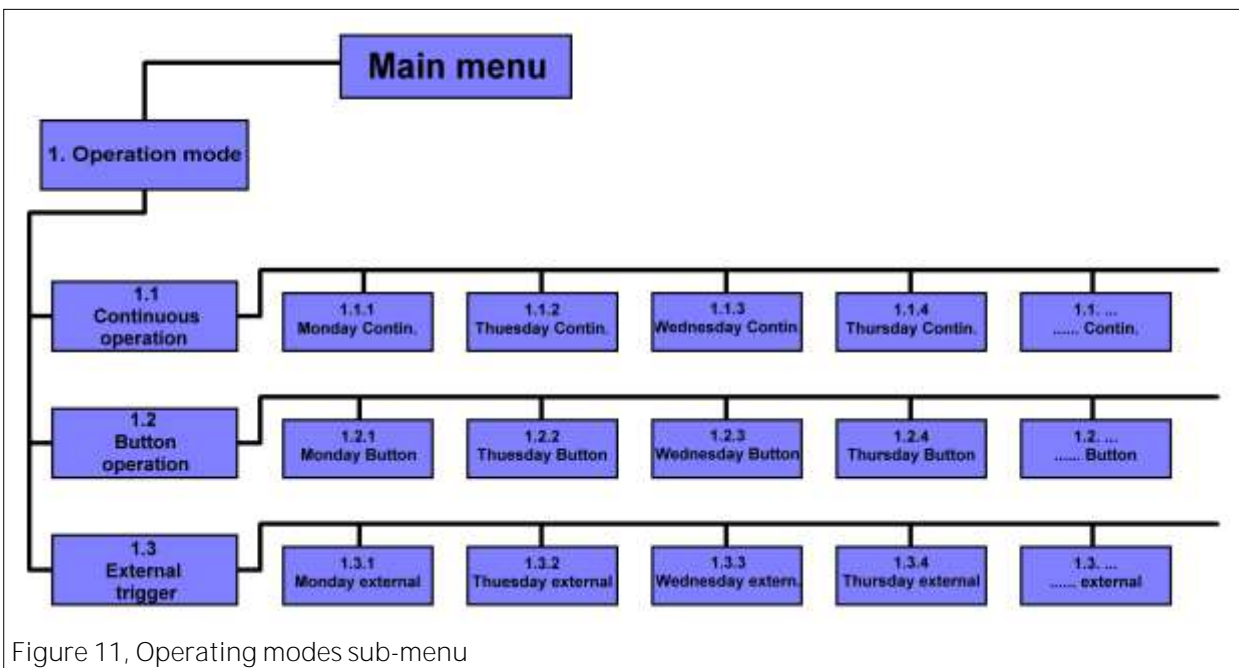

Settings sub-menu

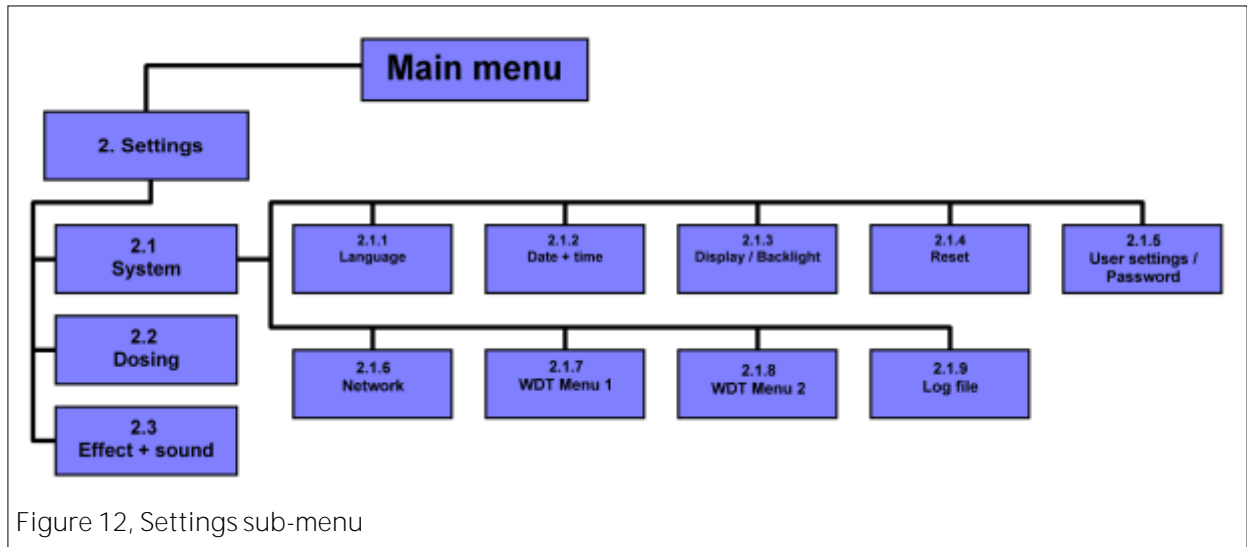

Figure 12, Settings sub-menu





6.3 The main menu

The main menu is displayed after switching on the device at the main switch located at its side.

5 main groups can be selected from the main menu.



Explanation of the symbols

1.  Operating modes
2.  Settings
3.  Service menu
4.  Login to the various rights levels
5.  Logout from the rights levels Successful logging off is indicated by a "0" in the information bar!

The information bar



The information bar remains visible at the bottom of the screen. It shows the following information.

- Display of the operating mode, e.g. Continuous
- Device description; Sol-Tec V3
- Level of user rights
- 00:00; Countdown to the next dosing; time indicator
- Day of week, date, time

The navigation field



After tapping the input field, the font turns white and the navigation field is automatically shown. The desired values are set with the arrow keys and confirmed with OK.

The values are saved with the SAVE button while ESC terminates the input process.

6.3.1 Login main menu

Login is required before settings can be entered into the device.

Touch the Login button  in the main menu to enter the password for the desired user level.

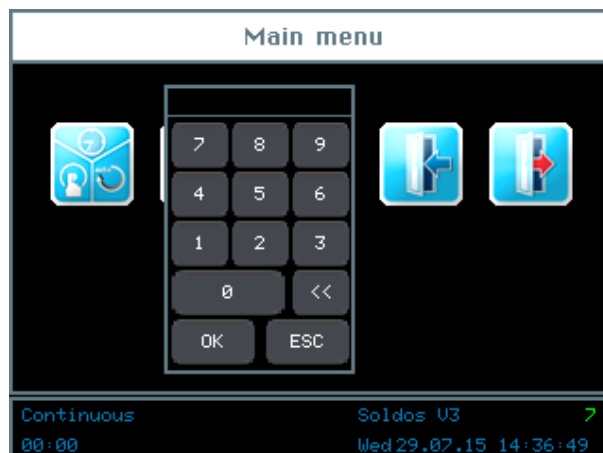

User levels from 0 to 7 exist for setting the controller.

User level 0	Guest	Reading rights
User level 1	End-user	Limited changes
User level 2	Technician 1	More complex changes
User level 3	Technician 2	More complex changes
User level 4	Technician 3	Access for company service technicians
User level 5	Reset password	Access for service partner
User level 6	EOS menu 1	Access for company service technicians
User level 7	EOS menu 2	Access for company service technicians



HINT !

The pre-installed passwords are provided in the operating data sheet in *Section 9.3*.

The respective user level is shown in green on the information bar of the display after successful login. The desired changes to the controller can be performed thereafter. Use the Logout button  to log out after completing the settings. Also see *Section 6.8*.

Automatic logout:

The display switches to the screen saver when a selectable time period has expired. After a further minute has elapsed, the screen saver is dimmed and an automatic logout to user level 0 is performed. The login process must be repeated before any settings can be made.

6.4 Operating modes menu

Operating modes



Explanation of the symbols



Return button

Touch the Return button to move back one user level.



Home button

Touch the Home button to get to the start menu.

You may choose between 3 operating modes:

1. Continuous dosing operating mode
2. Button operating mode
3. External control operating mode

The green frame shows the operating mode selected.

6.4.1 Continuous dosing operating mode

The continuous dosing operating mode can be used to divide each day of the week into 2 time blocks.

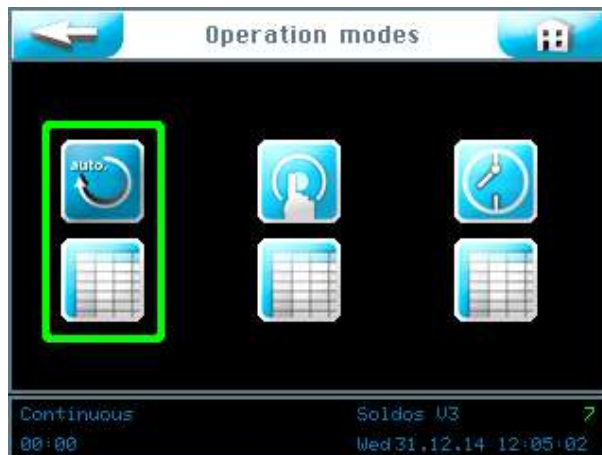

Start continuous dosing operating mode



Provide settings for continuous dosing

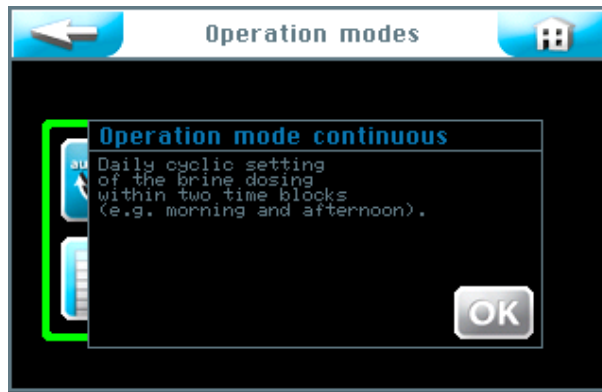

Confirm information text with .

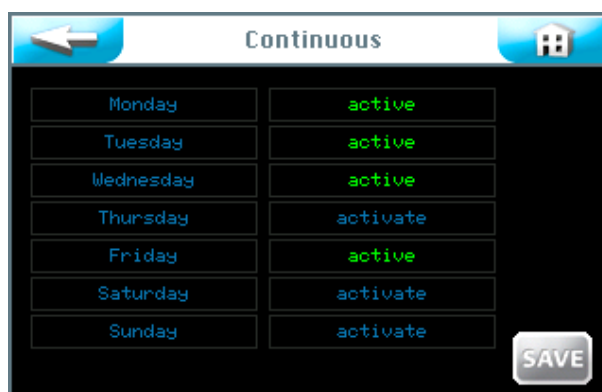

You can or deactivate each individual day of the week by pressing the corresponding button in the right column.

Touch the left column of the relevant day of the week to enter starting times and the corresponding parameters.

The cycle menu for each day of the week.

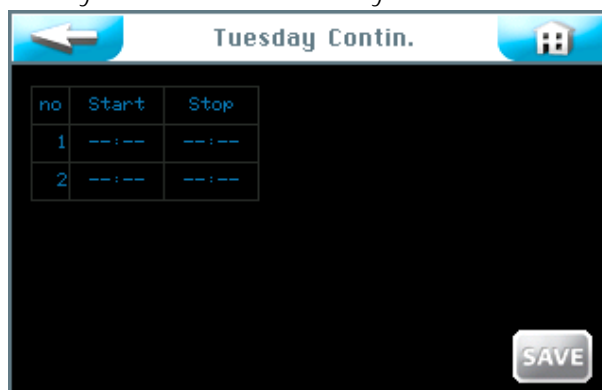

An empty input template is shown here. You can enter 2 different periods with appropriate parameters. The continuous dosing set is active in the steam room during these periods.



HINT!

A pause of at least 30 minutes must be between the time blocks!
An incorrect entry is marked with a red frame around the field **Start**.

The earliest Start time you can set is 00:01! The latest Start time you can set is 23:30! Otherwise, it may overlap with the next day.

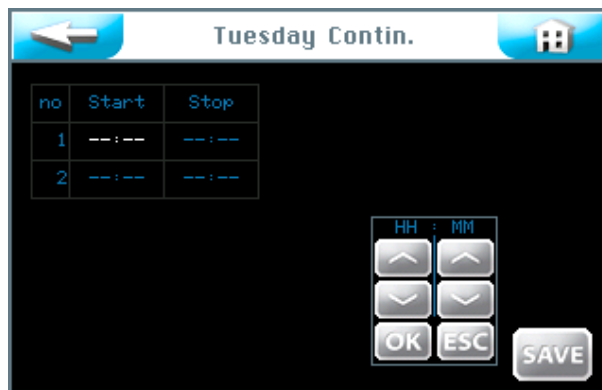

After tapping the input field, the font turns white and the navigation field is shown. Set the desired values and store them with **OK**.
Save the input with the **SAVE** button.

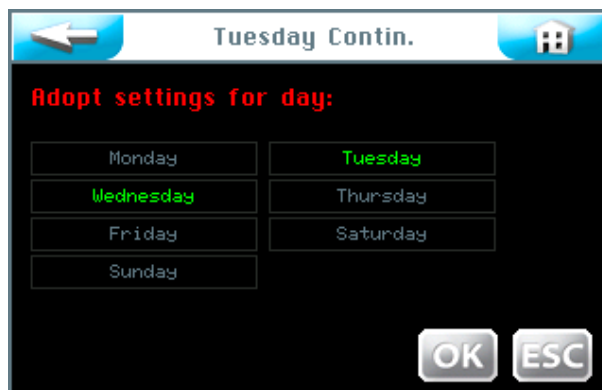

The controller then asks whether you want to accept the settings for other days as well. Mark all days for which you want to use the same settings in green and confirm the selection with **OK**.

Confirm with **OK** or terminate with **ESC**.

The button  leads to the previous view. (Repeated request to save)

6.4.2 Button operating mode

Button operation can be used to determine on which week days and at which times dosing can be started by the guests in the sauna room.



Start button operation



Enter settings for button operation

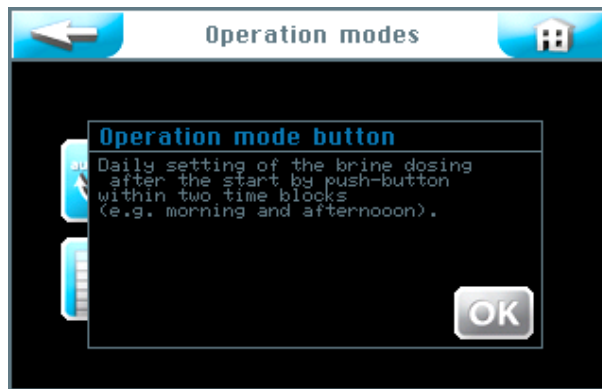

Confirm the information text with .



You can **activate** or deactivate each individual day of the week by pressing the corresponding button in the right column.

Touch the left column of the relevant day of the week to enter starting times and the corresponding parameters.

The button menu for each day of the week.

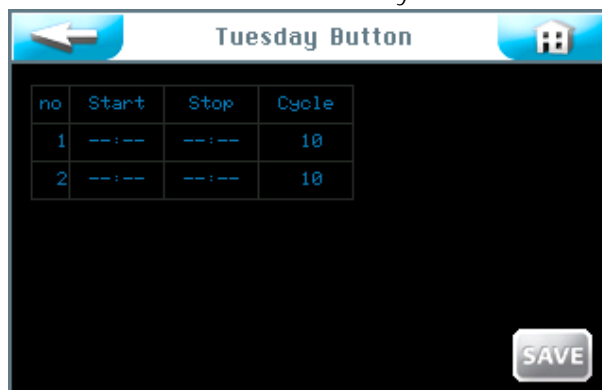

An empty input template is shown here. You can enter 2 different time blocks with their respective parameters. The buttons in the sauna room remain active during these periods.



HINT !

A pause of at least 30 minutes must be between the time blocks! An incorrect entry is marked with a red frame around the field **Start**.

The earliest Start time you can set is 00:01! The latest Start time you can set is 23:30! Otherwise, it may overlap with the next day.



After tapping the input field, the font turns white and the navigation field is shown. Set the values required and save the input.

The **cycle** column can be used to enter the cycle time in minutes. The device will proceed through the dosing and break times as specified. The expiry of this time stops the system. It can be restarted after a delay period.

Save the result with **OK**.

After completing the input, save the values with the **SAVE** button.

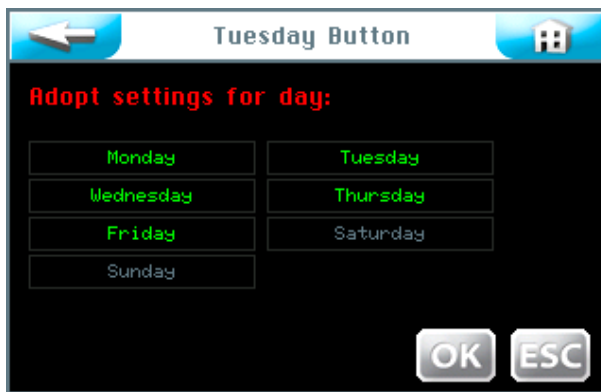

The controller then asks whether you want to accept the settings for other days as well. Mark all days for which you want to use the same settings in green and confirm the selection with **OK**.

Confirm with **OK** or terminate with **ESC**.

The button  leads to the previous view. (Repeated request to save)

6.4.3 External control operating mode

External control operating mode is used to set the time blocks. While these time-blocks are active, the Sol-Tec V3 system is operated by an external system, e.g. a EOS central controller. You can set 2 individual time blocks for each day of the week. The Sol-Tec V3 will only react to the input signal while these time blocks are active.



Start External Control operating mode



Perform settings for External Control operating mode

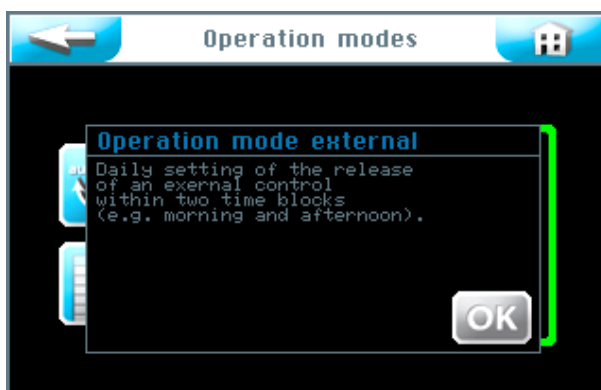

Confirm the information text with .



You can or deactivate each individual day of the week by pressing the corresponding button in the right column.

Touch the left column of the relevant day of the week to enter the starting and stop times.

The time settings for each day of the week



An empty input template is shown here. You can enter 2 different time blocks with their respective times. External control is possible during these periods.



HINT!

A pause of at least 30 minutes must be between the time blocks!
An incorrect entry is marked with a red frame around the field .

The earliest Start time you can set is 00:01! The latest Start time you can set is 23:30! Otherwise, it may overlap with the next day.



After tapping the input field, the font turns white and the navigation field is shown. Set the desired values and store them with **OK**.
 After completing the input, save the values with the **SAVE** button.

The controller then asks whether you want to accept the settings for other days as well. Mark all days for which you want to use the same settings in green and confirm the selection with **OK**.

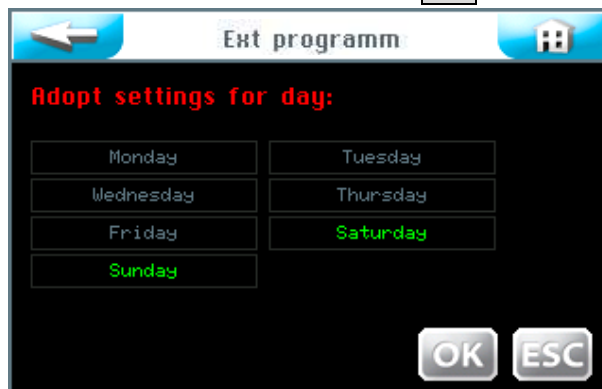

Confirm with **OK** or terminate with **ESC**.

The button  leads to the previous view. (Repeated request to save)

6.5 Settings menu

Settings regarding the system, dosing as well as effects and sound can be made here.



One of three settings groups can be selected on the touch screen:

1. System menu
2. Dosing
3. Effect + sound

The button  leads to the previous view.

6.5.1 System menu



One of 9 function can be selected on the touch screen:

1. Language
2. Date + time
3. Display and backlight
4. Reset
5. User settings / password allocation
6. Network
7. EOS menu 1
8. EOS menu 2
9. Log files

The button  leads to the previous view.

6.5.1.1 Language

Select the preferred language.



The button  leads to the previous view.

6.5.1.2 Date + time

The required date and time can be set by using the arrow keys. Save and complete the entry with the **SAVE** button.

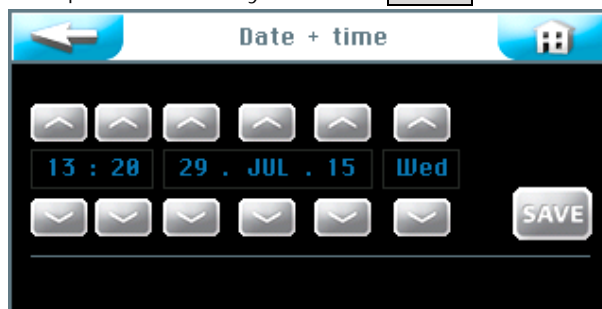

The button  leads to the previous view.



HINT !

The adaptation of the time to summer and winter time must be manually performed!

6.5.1.3 Display + backlight

The settings for the display and buttons can be entered here.

The display switches to full **display brightness** when the touch panel is touched. The display switches back to the screen saver after the predefined **Delay** has elapsed. One minute later, the screen saver is dimmed to the **Display dimmed** value and an automatic logout to user level 0 is performed.

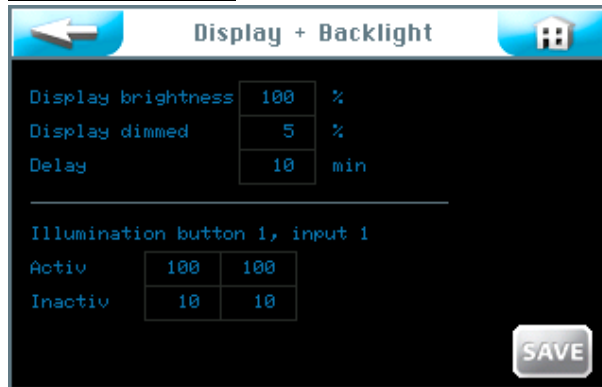

The button illumination in % can be set for the active and inactive button and for the external input.

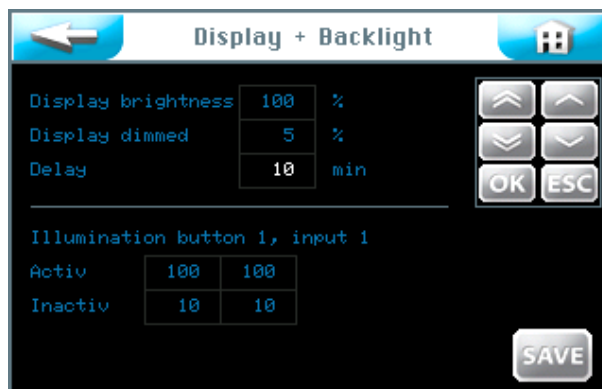

After tapping the input field, the font turns white and the navigation field is shown. Set the values required and save the input.



HINT!

Enter the values set into the operating data sheet *Section 9.3*. The factory settings are also provided in the operating data sheet.

Store the data with the **SAVE** button once the entry is completed. Confirm with **OK** or terminate with **ESC**.

The button  leads to the previous view. (Repeated request to save)

6.5.1.4 Reset

Press the **Reset** button in the Systems menu when you want to reset the controller to factory settings.



Resetting to factory settings depends on the user level at which you are logged in. (Factory settings see operating data sheet in *Section 9.4.*)

The values of the following menu ranges are set to factory settings on User Levels 2 and 3:

Button operation, display and back-light, splash as well as announcement and heater

On User Level 5, all passwords on User Levels 1-4 are reset, in addition to User Level 3.

On User Level 6, the time and weekday settings are reset as well.

On User Level 7, also the product name, serial number and date and time are reset.

On User Level 4, the network settings are reset.



Confirm your selection with **OK** to reset the software to factory settings or terminate the process with **ESC**.

6.5.1.5 User settings / password allocation

The passwords for the different user levels can be changed here. The default passwords can be found in the operating data sheet in *Section 9.3*.



Select which password is to be changed.

User level 1	End-user	The password must have 4 characters
User level 2	Technician 1	The password must have 5 characters
User level 3	Technician 2	The password must have 6 characters
User level 4	Technician 3	The password must have 7 characters



Enter the respective password and confirm the entry with **OK**.

The password was successfully changed when the display returns to the "System Menu" after the last entry. The user level selected will be shown in green in the information line.



HINT !

Enter the changed password in the operating data sheet.

6.5.1.6 Network

This function is currently not active.

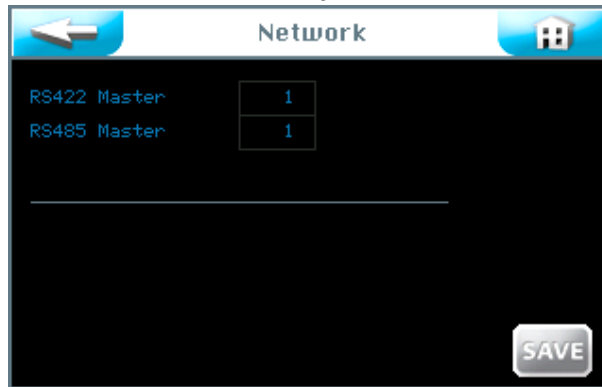

6.5.1.7 EOS Menu 1

The operator has reading rights for this menu. Changes may only be performed by the EOS company customer service.



6.5.1.8 EOS Menu 2

The operator has reading rights for this menu. Changes may only be performed by the EOS company customer service.

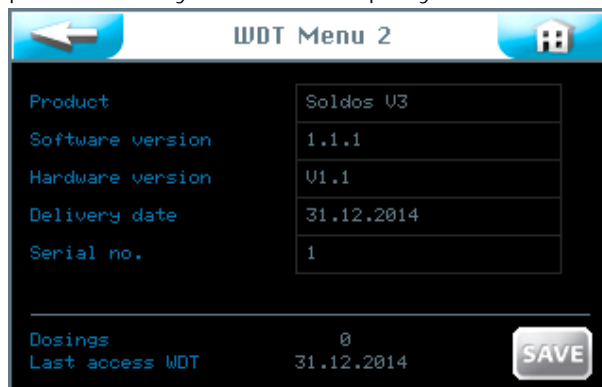

6.5.1.9 Log files

The log file, including the last 255 events, is stored by the software. Faulty results are shown in red.

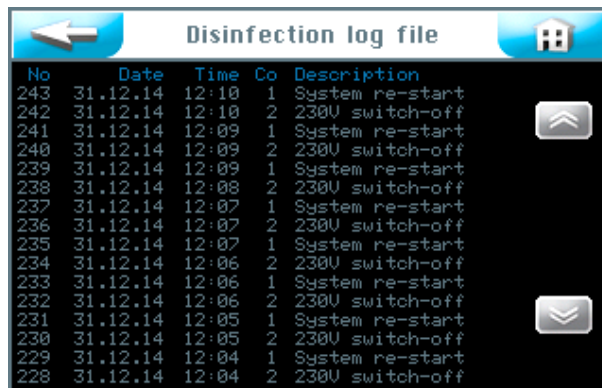

No	Date	Time	Co	Description
243	31.12.14	12:10	1	System re-start
242	31.12.14	12:10	2	230U switch-off
241	31.12.14	12:09	1	System re-start
240	31.12.14	12:09	2	230U switch-off
239	31.12.14	12:09	1	System re-start
238	31.12.14	12:08	2	230U switch-off
237	31.12.14	12:07	1	System re-start
236	31.12.14	12:07	2	230U switch-off
235	31.12.14	12:07	1	System re-start
234	31.12.14	12:06	2	230U switch-off
233	31.12.14	12:06	1	System re-start
232	31.12.14	12:06	2	230U switch-off
231	31.12.14	12:05	1	System re-start
230	31.12.14	12:05	2	230U switch-off
229	31.12.14	12:04	1	System re-start
228	31.12.14	12:04	2	230U switch-off

6.5.2 Dosing menu

The Dosing menu is used to set the brine dosing parameters.



Pre-indication	1	sec	active
Dosing time	10	sec	
Pause time	4	min	
Brine infusion	10	sec	
Hose length	10	m	

SAVE

Pre-indication:

Set the time for announcement by action (e.g. light) here. Announcement means that an action is triggered to announce the upcoming brine splash to the guest. You can deactivate this announcement.

Dosing time:

Duration of brine dosing.

Pause time:

The break between two dosing repeats

Brine infusion:

Duration of brine dosing triggered by a button press. (only possible with continuous dosing operating mode)

Hose length:

The length of the dosing hose installed from the nebulization device to the nozzle.

Touch the numeric keys to provide settings.

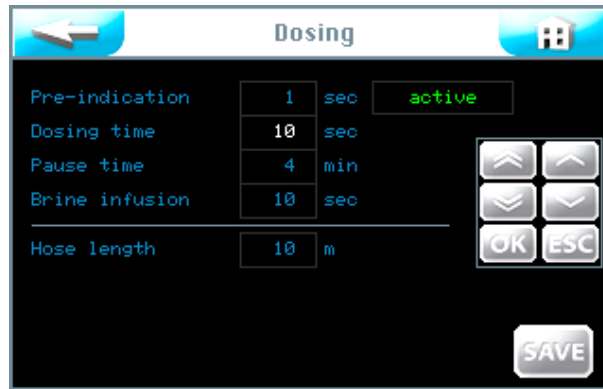

After tapping the input field, the font turns white and the navigation field is shown. Set the desired values and store them with **OK**.

Confirm with **OK** or terminate with **ESC**.

The button  leads to the previous view. (Repeated request to save)

6.5.3 Effect illumination and sound menu

In the main menu touch **Settings** → **Effect + Sound**.

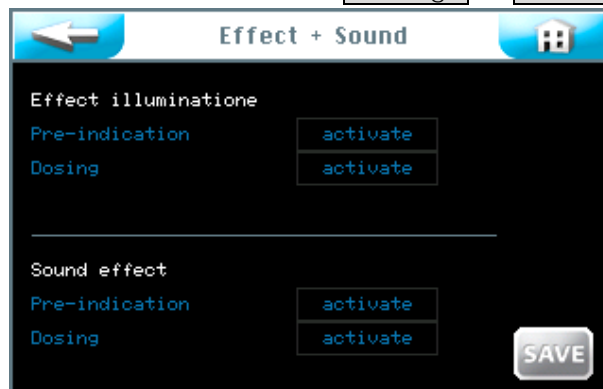

Effect illumination:

This signal can be used to trigger a light effect for dosing announcement and/or during dosing. The effect lighting can be used for announcement and/or during dosing.

Pre-indication:

Lead-up time before dosing The time is taken from the announcement setting in the dosing menu, see *Section 6.5.2*.

Dosing:

Dosing duration: The time is taken from the dosing time setting in the dosing menu, see *Section 6.5.2*.

Sound effect:

This signal can be used to trigger a sound effect to announce dosing and/or during dosing. The sound effect can be activated for announcement and/or during dosing.

Pre-indication:

Lead-up time before dosing The time is taken from the announcement setting in the dosing menu, see *Section 6.5.2*.

Dosing:

Dosing duration: The time is taken from the dosing time setting in the Dosing menu, see *Section 6.5.2*.

Store the data with **SAVE** once the entry has been completed.

Confirm with **OK** or terminate with **ESC**.

The button  leads to the previous view. (Repeated request to save)

6.6 Service menu

The service menu can be used for functional tests of the actuators and the controller. They are also used for fault searches.

The service menu also includes device information.

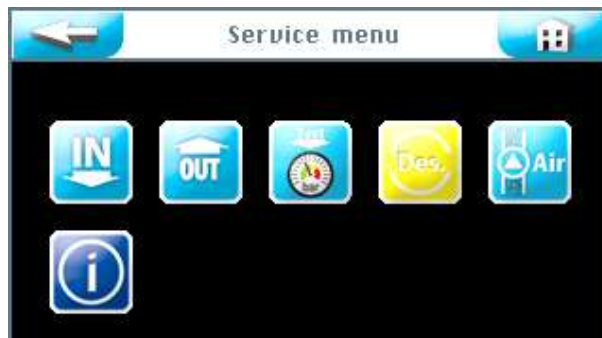

You can select one of 6 menus with the touch screen:

1. Inputs test menu
2. Outputs test menu
3. Pressure switch test menu
4. Perform disinfection

5. Bleed the pump
6. Information test menu

6.6.1 Inputs test menu

This function can be used to test the 3 electrical inputs to the controller.

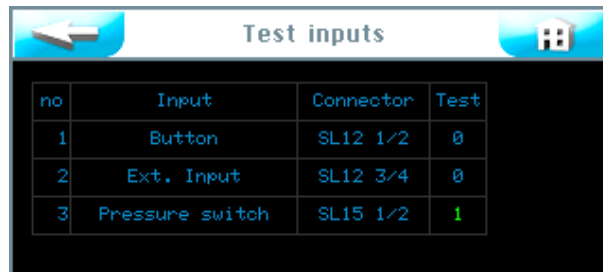

no	Input	Connector	Test
1	Button	SL12 1/2	0
2	Ext. Input	SL12 3/4	0
3	Pressure switch	SL15 1/2	1

The test column shows the actual state for the respective input. Select the desired test line and start it in the test column.

If the electrical input is open, than no electrical signal is provided to the input, a 0 is shown.

If the electrical input is closed, than an electrical signal is provided to the input, a green 1 is shown.

Explanation:

Button: A signal from the button is provided (only when button operation is active).

External input: A signal from an external unit is pending. (e.g. from EOS central controller)

Pressure switch: A signal is provided by the pressure switch. (only Soldos SL)

SL12 1/2: Number of clamp and number of the clamp strip on the control panel.

6.6.2 Outputs test menu

This function can be used to test the electrical outputs of the controller.

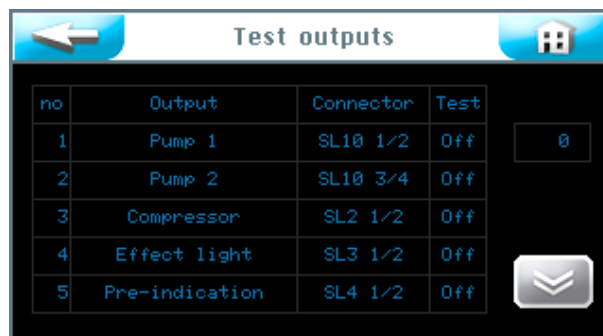

no	Output	Connector	Test
1	Pump 1	SL10 1/2	Off
2	Pump 2	SL10 3/4	Off
3	Compressor	SL2 1/2	Off
4	Effect light	SL3 1/2	Off
5	Pre-indication	SL4 1/2	Off

Select the desired test line and start it in the test column.

Test no. 1 to 5

no	Output	Connector	Test
1	Pump 1	SL10 1/2	Off
2	Pump 2	SL10 3/4	Test
3	Compressor	SL2 1/2	Off
4	Effect light	SL3 1/2	Off
5	Pre-indication	SL4 1/2	Off

The word **Test** appears in a green font in the field and the timer counts from 30 seconds to 0.

An electrical signal is provided at the output during this time. A consumer connected to this output will operate during these 30 seconds.

Press the Button **Test** to cancel the test procedure.

Test no. 6 to 10

no	Output	Connector	Test
6	fault indication	SL6	Off
7	Sound	SL7	Off
8	Standby	SL8	Off
9	Button ill. 1	SL11 1/2	Off
10	Ext Feedback	SL11 3/4	Off

6.6.3 Pressure sensor test menu

This test is used to check the function of the pressure sensor.

Parameter	Value	Action
Pressure switch	0.0 bar	Start
Debounce time	10 sec	
Operation time	15 sec	
Pressure switch	0.0 bar	Start
Debounce time	10 sec	
Operation time	15 sec	

Press start for Pressure Sensor 1 or Pressure Sensor 2 (version with 2 dosing pumps).

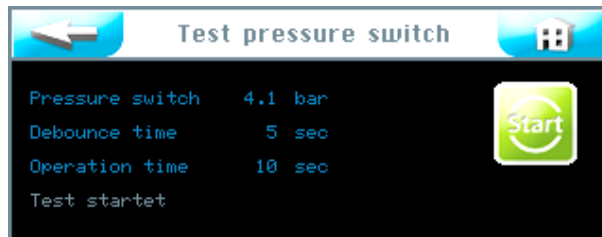

The test is running.

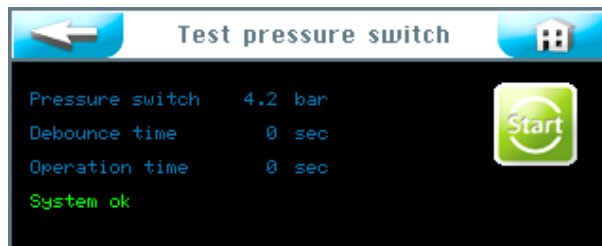

The test was successful



HINT!

In the event of a fault message see *Section 7.3, Fault removal / fault codes*.

6.6.4 Perform disinfection

See *Section 5.2.1, Disinfection and rinsing of the Sol-Tec V3*

6.6.5 Bleed the pump

See Section 5.2, Bleed pump

6.6.6 Information test menu

Touch the **Info** button in the service menu to show the device data.



6.7 Login

See *Section 6.3.1*.

6.8 Logout

Touch the **Logout** button in the main menu to change to User Level 0 (operating level). The display in the information bar changes to 0.



Automatic logout:

The display switches to the screen saver when a selectable time period has expired. After a further minute has elapsed, the screen saver is dimmed and an automatic logout to user level 0 is performed.

The login process must be repeated before any settings can be made.

6.9 Optional functions

- Light effects
- Sound effects
- Collective fault message

Further information on these topics are available from your specialist dealer.

6.10 Top up consumables

Refill brine:

See *Section 5.2.1, Disinfecting and rinsing the Sol-Tec V3*

7 Maintenance, service, faults

7.1 Device maintenance

It is recommended to task a specialist company with maintenance.

The following points must be considered to ensure problem-free and germ-free operation of the Soldos:

1. Disinfection and maintenance according to the maintenance protocol in *Section 9.4*



CAUTION!

Disinfection must be performed whenever the polyethylene container is changed but at least every 28 days!

2. Regular cleaning of the device. Brine water leaves ugly stains and corrodes metals when it is not wiped off.
3. Stocking of necessary consumables

7.2 Regular water inspection

Not required

7.3 Fault removal / fault codes



HINT!

It is furthermore possible that the switches or sensors are faulty and that it is therefore not possible to transmit an electrical signal.

Dosing is interrupted in response to a device fault.

Fault indications

See the following fault table for removing the fault messages

Message 1: Disinfection pre-indication

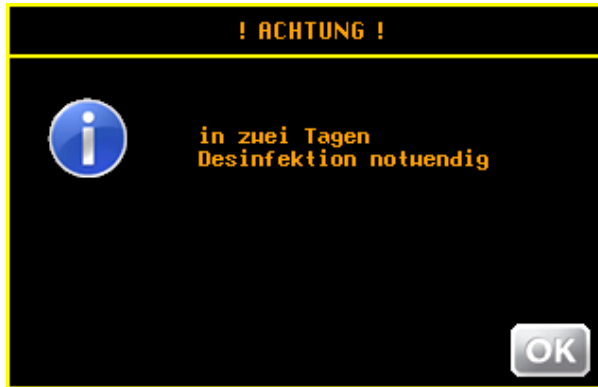

Pre-indication of disinfection You can perform the disinfection already. The pre-indication is repeated after 1 day.

Message 2: Disinfection necessary



Perform the disinfection.

Message 3: Disinfection has failed, nozzle clogged



Message 4: Disinfection has failed, polyethylene container empty



The disinfection must be repeated.

Message 5: Overpressure!



Message 6: Pressure sensor test, brine empty

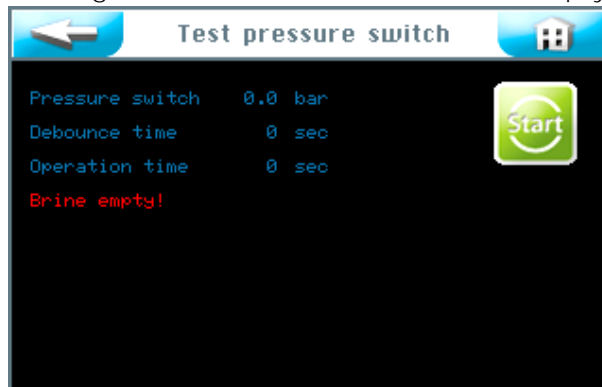

Fault table

Fault indication	Effect	Cause / remedies
Message 1: Disinfection pre-warning	<ul style="list-style-type: none"> • No effect, only indication 	<ul style="list-style-type: none"> • Disinfection can be performed
Message 2: Disinfection necessary	<ul style="list-style-type: none"> • No effect, only indication 	<ul style="list-style-type: none"> • Perform disinfection
Message 3: Disinfection has failed, nozzle clogged	<ul style="list-style-type: none"> • Disinfectant cannot be transported. 	<ul style="list-style-type: none"> • Clean nozzle and repeat disinfection
Message 4: Disinfection has failed, polyethylene container empty	<ul style="list-style-type: none"> • Disinfection cannot be completed 	<ul style="list-style-type: none"> • Too little disinfectant, perform another disinfection with a larger amount of disinfectant
Message 5: Overpressure!	<ul style="list-style-type: none"> • Disinfection was terminated 	<ul style="list-style-type: none"> • Check pipes • Check pressure sensor
Message 6: Pressure sensor test, brine empty	<ul style="list-style-type: none"> • The device has stopped 	<ul style="list-style-type: none"> • Polyethylene container empty → Connect new brine container • Pipes leak → Check / replace pipes
No nebulising / faulty spray pattern	<ul style="list-style-type: none"> • No nebulising / faulty spray pattern 	<ul style="list-style-type: none"> • Nozzle encrusted → Clean nozzle • Check brine level in the polyethylene container / Top up polyethylene container and check pressure sensor • Leaking pipes → Check the device for leaks • Pump has no power → Replace pump
The device cannot be switched on	<ul style="list-style-type: none"> • Main fuse F0 defective • Main switch defective • Power supply interrupted 	<ul style="list-style-type: none"> • Check or exchange the fuse • Check main switch • Check the power supply
System does not work	<ul style="list-style-type: none"> • Wrong setting • Main fuse F1 at main PC board defective 	<ul style="list-style-type: none"> • Check / reset settings • Exchange main switch F1
Effect illumination does not work	<ul style="list-style-type: none"> • Fuse F3 effect illumination defective • Wrong setting 	<ul style="list-style-type: none"> • Exchange fuse F3 • Check / reset settings
Announcement does not work	<ul style="list-style-type: none"> • Fuse F4 for announcement defective • Wrong setting 	<ul style="list-style-type: none"> • Exchange fuse F4 • Check / reset settings
1 dosing pump without function	<ul style="list-style-type: none"> • Fuses F10 - F11 defective • Dosing pump defective 	<ul style="list-style-type: none"> • Exchange fuses F10 and/or F11 • Replace pump
Button illumination does not work	<ul style="list-style-type: none"> • Fuse F14 defective 	<ul style="list-style-type: none"> • Exchange fuse F14
No dosing	<ul style="list-style-type: none"> • Fuses defective • Dosing pump defective • Nozzle clogged: 	<ul style="list-style-type: none"> • Check fuses • Check / exchange pump • Check / clean / exchange nozzle
Wrong time	<ul style="list-style-type: none"> • Power supply interrupted for more than 20 days • Buffer capacitor defective 	<ul style="list-style-type: none"> • Reset the time • replace panel

8 Shutting down – Storage – Disposal

8.1 General

Shutting down

The device must be completely emptied when it is shut down!

Shut-downs for at most 14 days only require switching of the main switch.

Shut-downs longer than 14 days require the brine container to be removed and replaced with a new one at start-up.

Blow all lines clear with compressed air when shutting down.

Disposal of old part and operating materials

Thoroughly clean disassembled, contaminated parts before disposing of them.

Used parts and operating materials must be disposed of according to the regulations at the place of operation or recycled. Please take note of the respective instruction on the packaging when the operating materials are subject to specific regulations. In case of doubt you can obtain information from the institution responsible for disposal in your region or from the manufacturer.

When this is not possible, dispose of them as special waste.

9 Documents

9.1 Terminal plans

Note regarding terminal plans: The special terminal plans adapted to optional equipment of the brine nebulization station 1kg and 5kg are stored in the switch cabinet of the device.

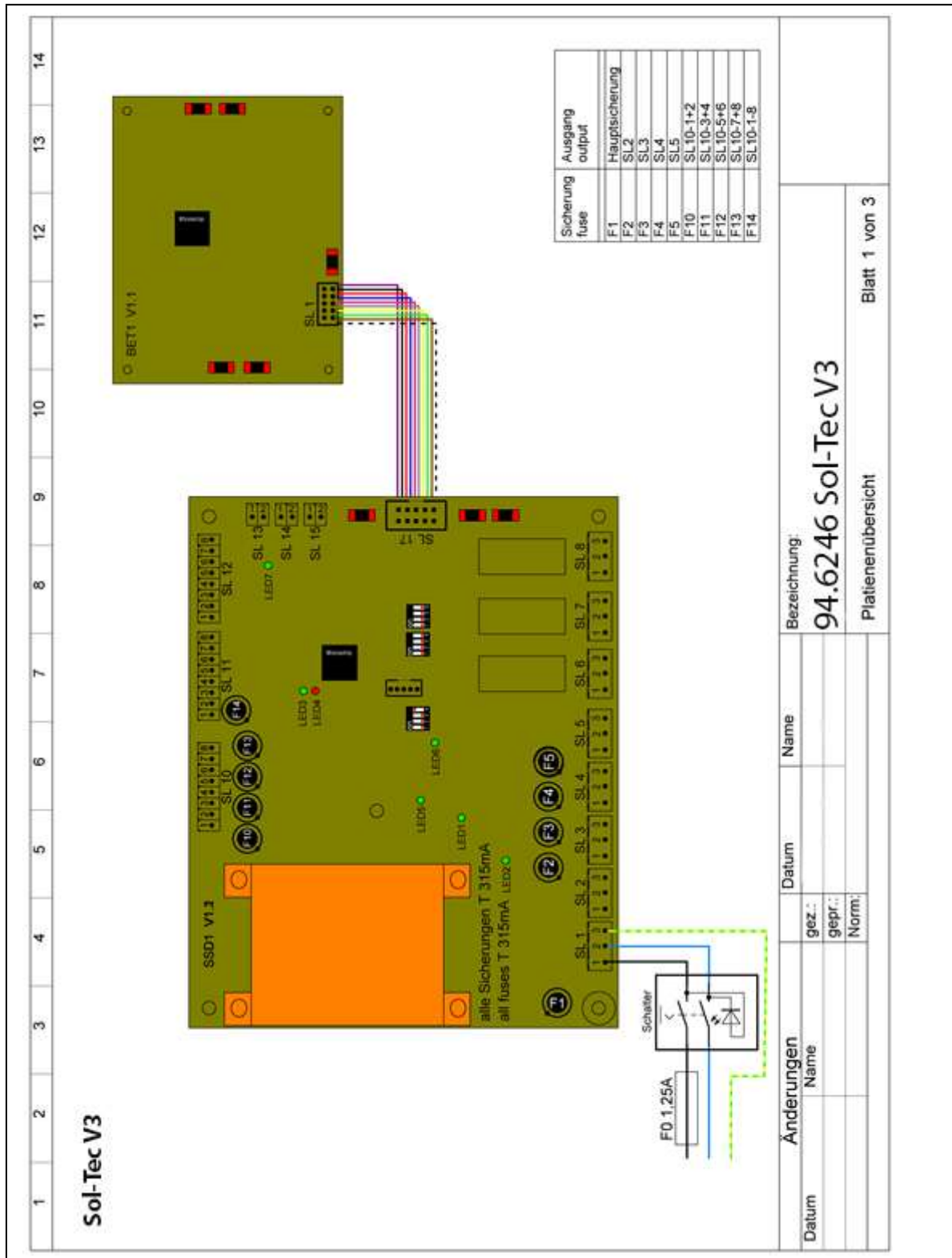

1	2	3	4	5	6	7	8	9	10	11	12	13	14																												
Soldos V3																																									
Ausgänge / output																																									
<p>SL 1 230V Spannungsversorgung power supply</p>																																									
<p>SL 2 230V max. 60W ohne Funktion without function</p>																																									
<p>SL 3 230V max. 60W Effektbeleuchtung effect lighting</p>																																									
<p>SL 4 230V max. 60W Vorankündigung pre-indication</p>																																									
<p>SL 5 230V max. 60W ohne Funktion without function</p>																																									
<p>SL 6 p-free (8A 230V/AC) Störmeldung fault indication</p>																																									
<p>SL 7 p-free (8A 230V/AC) Soundeffekt Sound</p>																																									
<p>SL 8 p-free (8A 230V/AC) ohne Funktion without function</p>																																									
Ausgänge / output																																									
<p>SL 10 24V/DC + - - + - - + - - 1) + Solepumpe 1 birne solution pump 1 2) GND Solepumpe 1 birne solution pump 1 3) + Solepumpe 2 birne solution pump 2 4) GND Solepumpe 2 birne solution pump 2 5) + 6) GND 7) + 8) GND</p>																																									
Ausgänge / output																																									
<p>SL 11 24V/DC + - - + - - + - - 1) + Beleuchtung Taster 1 illumination push-button 1 2) GND Beleuchtung Taster 1 illumination push-button 1 3) + 4) GND 5) + 6) GND 7) + 8) GND</p>																																									
Ausgänge / output																																									
<p>SL 12 24V/DC IN - IN - IN - IN - IN - 1) IN Taster 1/ push-button 1 2) GND Taster 1/ push-button 1 3) IN externe Ansteuerung external control contact 4) GND externe Ansteuerung external control contact 5) IN 6) GND 7) IN 8) GND</p>																																									
Eingänge / input																																									
<p>SL 13 4-20 mA IN - 1) IN Drucksensor Pumpe 1 pressure sensor pump 1 2) GND Drucksensor Pumpe 1 pressure sensor pump 1</p>																																									
Eingänge / input																																									
<p>SL 14 4-20 mA IN - 1) IN Drucksensor Pumpe 2 pressure sensor pump 2 2) GND Drucksensor Pumpe 2 pressure sensor pump 2</p>																																									
Eingänge / input																																									
<p>SL 15 24V/DC IN - 1) IN ohne Funktion without function 2) GND ohne Funktion without function</p>																																									
Drucksensor 4-20mA pressure sensor 4-20mA																																									
<p>Pumpe 1 SL13/ 1 2 Pumpe 2 SL13/ 1 2</p>																																									
<table border="1"> <tr> <td colspan="2">Änderungen</td> <td colspan="2">Bezeichnung:</td> </tr> <tr> <td>Datum</td> <td>Name</td> <td colspan="2">94.6246 Sol-Tec V3</td> </tr> <tr> <td>17.07.17</td> <td>RS</td> <td>gez.:</td> <td>FM</td> </tr> <tr> <td></td> <td></td> <td>gepr.:</td> <td></td> </tr> <tr> <td></td> <td></td> <td>Norm:</td> <td></td> </tr> <tr> <td colspan="2"></td> <td colspan="2">Ein/Ausgänge</td> </tr> <tr> <td colspan="2"></td> <td colspan="2">Blatt 2 von 3</td> </tr> </table>														Änderungen		Bezeichnung:		Datum	Name	94.6246 Sol-Tec V3		17.07.17	RS	gez.:	FM			gepr.:				Norm:				Ein/Ausgänge				Blatt 2 von 3	
Änderungen		Bezeichnung:																																							
Datum	Name	94.6246 Sol-Tec V3																																							
17.07.17	RS	gez.:	FM																																						
		gepr.:																																							
		Norm:																																							
		Ein/Ausgänge																																							
		Blatt 2 von 3																																							

9.2 Commissioning protocol / instruction

This protocol is to be completed by the commissioning technician! All warranty claims expire when no completed and signed commissioning protocol is available!

The commissioning protocol is included in the documents attached.



HINT!

Enter the operating parameters on the operating data sheet during commissioning!

Settings menu	Factory settings	Setting ranges	Step	During commissioning	Optimised during operation
				Date:	Date:
Display and backlight					
Display brightness	100%	5-100%	1		
Display dimmed	5%	5-100%	1		
Delay	10 min	10-60 min	1		
Background lighting Button 1 active / inactive.	100% 10%	0-100% / 0-100%	1		
Background lighting Button 2 active / inactive.	100% 10%	0-100% / 0-100%	1		
Password allocation					
Password guest	No password	---			
Password final customer	0123	0000-9999			
Password technician 1	01234	00000-99999			
Password technician 2	012345	000000- 999999			
Dosing					
Announcement time	1sec	1-60sec	1		
Announcement active / activate	activate	active / activate			
Dosing time	10sec	5-60sec	1		
Pause time	4min.	1-60min	1		
Brine splash	10sec	5-60sec	1		
Hose length	10m	5-30m	1		
Effect illumination: + sound					
Announcement effect lighting	activate	active / activate	---		
Dosing effect lighting	activate	active / activate	---		
Announcement by sound	activate	active / activate	---		
Dosing sound	activate	active / activate	---		

Operating data sheet

Settings menu	Factory settings	Setting ranges	Step	During commissioning	Optimised during operation
				Date:	Date:
Display and backlight					
Display brightness	100%	5-100%	1		
Display dimmed	5%	5-100%	1		
Delay	10min	10-60min	1		
Background lighting Button 1 active / inactive.	100% 10%	0-100% / 0-100%	1		
Background lighting Button 2 active / inactive.	100% 10%	0-100% / 0-100%	1		
Password allocation					
Password guest	No password	---			
Password final customer	0123	0000-9999			
Password technician 1	01234	00000-99999			
Password technician 2	012345	000000- 999999			
Dosing					
Announcement time	1sec	1-60sec	1		
Announcement active / activate	activate	active / activate			
Dosing time	10sec	5-60sec	1		
Pause time	4min.	1-60min	1		
Brine splash	10sec	5-60sec	1		
Hose length	10m	5-30m	1		
Effect illumination: + sound					
Announcement effect lighting	activate	active / activate	---		
Dosing effect lighting	activate	active / activate	---		
Announcement by sound	activate	active / activate	---		
Dosing sound	activate	active / activate	---		

9.4 Maintenance protocol

The maintenance protocol is included in the documents attached.



ATTENTION: !

Disinfection is required at each polyethylene container change and at least every 28 days!

Maintenance of brine rooms

We recommend rinsing the inside area of steam baths at the end of the operation with water, so that no salt deposits or crusts can form.

**HINT !**

Do you need spare parts, wearing parts or consumables? Please feel free to request them from your service partner or specialist dealer.

Spare parts list

<u>Device</u>	<u>Pos</u>	<u>Description</u>	<u>Reference no.</u>
Control		Fuse bag 2x1.25A slow, 5x20	16842
		Fuse bag 2x315mA slow 8.3x8	23625
		Controller SSD IO-board	24341
		Controller SSD Touch 3,2"	24305
		Touch input stylus	24168
Dosing technology	3	Membrane pump NF1.25 for Soldos	24269
	11	Pressure sensor C08	24256
	11	Adapter pressure sensor dia50-1/4"-Sole	24500
	13	Canister connection brine coupling	17437
	13	Banister connection V3 brine connector	24542
		V3 brine nebulising nozzle complete with cover and wall feed-through	24545
		Hollow-cone spray nozzle for Sol-Tec V3 brine nebuliser	24547
		Dosing line PTFE 4x1 mm	10432
		Union nut 6mm PP 1/4"	11003
Disinfection set		Disinfection set Sol-Tec V2 + V3	19873
Options		Non-return valve - 1S 4x1- M 1/4" is installed in dosing line 4x1, two hose connections 4x1 for Soldos	16155
		Impulse damper for Soldos	21629

List of consumables

<u>Device</u>		<u>Description</u>	<u>Reference no.</u>
Brine		5% brine in 1 kg polyethylene container	17519
		5% brine in 5 kg polyethylene container	17613
		5% brine in carton: 6x1 kg	17669
		5% brine in carton: 6x5kg	17667
Disinfection		1 SOL-TEC disinfection tablet	19871
		5 SOL-TEC disinfection tablets	24907
		20 SOL-TEC disinfection tablets	24907
		25 SOL-TEC disinfection tablets	19871-1

An opened brine polyethylene container is usable for 28 days. It must then be disposed of with the remaining content!

10 Appendices

Own notes
